

Avide LED Flood Light 10W NW 4000K PIR

Product code: ABFLNW-10W-PIR
Brand link: avidelighting.com/qr/ABFLNW-10W-PIR
ID: AB-190518
Company name: Bramcke Hungary Kft.
Company address: Kishatár utca 17., 4031 Debrecen



Date of issue: 2024-05-21

Page: 1/3

SPECIFICATIONS

EAN code: 5999562283042
Warranty: 3year(s)
Working temperature: -20 - +40 °C
Packaging: 1/b 10/c 700/p
Certifications: CE

TECHNICAL DETAILS

Wattage: 10W
Voltage: 85-265V
Beam angle: 120°
Dimmability: No
Lumen output: 900lm
Color temperature: 4 000K
Lifetime: 25 000h
Energy class: G
Type of LED: COB
Driver: CCD
CRI: >80
IP standard: IP65

BOX PICTURE



Avide LED Flood Light 10W NW 4000K PIR

Product code: ABFLNW-10W-PIR
Brand link: avidelighting.com/qr/ABFLNW-10W-PIR
ID: AB-190518
Company name: Bramcke Hungary Kft.
Company address: Kishatár utca 17., 4031 Debrecen



Date of issue: 2024-05-21

Page: 2/3

PRODUCT SIZE

Width: 115mm
 Height: 158mm
 Depth: 90mm

CARDBOARD BOX

EAN: 5999562283042
 Packaging: 1/b 10/c 700/p
 Dimensions: 120mm x 180mm x 80mm
 Net weight: 166.5g
 Gross weight: 172g

CARTON

EAN: 5999562283516
 Packaging: 1/b 10/c 700/p
 Dimensions: 555mm x 195mm x 255mm
 Net weight: 1.66496kg
 Gross weight: 1.72kg

PALLET EXAMPLE

Height:
 Width: 120cm (std Euro pallet)
 Mepth: 80cm (std Euro pallet)
 Cartons per pallet: 70carton/pallet
 Cartons per row:
 Net weight: 116.5472kg
 Gross weight: 120.4kg

PRODUCT PICTURE



PRODUCT OUTLINE

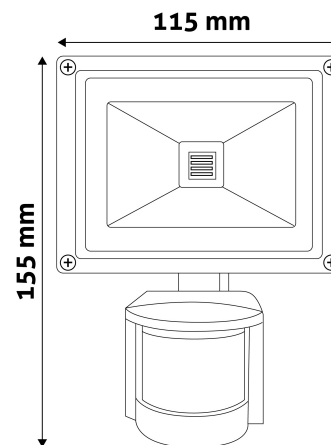

Avide LED Flood Light 10W NW 4000K PIR

Product code:	ABFLNW-10W-PIR
Brand link:	avidelighting.com/qr/ABFLNW-10W-PIR
ID:	AB-190518
Company name:	Bramcke Hungary Kft.
Company address:	Kisatár utca 17., 4031 Debrecen

QR code:



Date of issue: 2024-05-21

Page: 3/3

PRODUCT DESCRIPTION

The Avide COB Floodlights are also available with a built-in PIR motion sensor. With the help of the 3 potentiometers on the back of the floodlight the detection distance, the lighting length and the value of the twilight switch can be set easily to suit your preferences. The floodlights equipped with the PIR motion sensor are also suitable for both indoor and outdoor use due to their IP65 classification and they also feature the moveable metal frame that can be used for easy mounting on practically any surface.

The battery-operated Avide COB LED floodlights enable portable, mobile use. Brightness is adjustable in two stages. They can provide the same brightness as traditional halogen floodlights but with much lower power consumption; thus when operated from a battery, they can ensure a longer operating time. The battery of the floodlight can be fully charged in 3 hours and with one full charge it can operate for up to 5 hours. COB (chip-on-board) represents one of the most recent LED technologies, focusing the emitted light much better and thus providing better lighting at a longer distance. LED floodlights can provide up to 20 times longer lifetime compared to products using traditional light bulbs. Due to its IP65 classification, it is perfectly suitable for both indoor and outdoor use. The edge of the floodlight features a metal frame that makes it possible to be turned and tilted, thus enabling you to adjust the adequate lighting angle.

The LED floodlights are sold with a 30 cm long cable end and the plug is not included in the package! The product may only be installed by a professional! Any operation with the power on carries the hazard of an electric shock.

The Avide COB Floodlights with a PIR motion sensor are available in neutral white (NW) / cold white (CW) color temperatures in 10W / 20W / 30W power output versions. The Avide COB Floodlights with a PIR motion sensor are available in neutral white (NW) / cold white (CW) color temperatures in 10W / 20W / 30W power output versions.