

**Avide GU10 Frame Square Chrome**

**Product code:** ABGU10F-S-CH  
**Brand link:** [avidelighting.com/qr/ABGU10F-S-CH](http://avidelighting.com/qr/ABGU10F-S-CH)  
**ID:** AB-190518  
**Company name:** Bramcke Hungary Kft.  
**Company address:** Kishatár utca 17., 4031 Debrecen



**Date of issue:** 2024-05-21

**Page:** 1/3

**SPECIFICATIONS**

**EAN code:** 5999097911687  
**Warranty:** 2year(s)  
**Socket:** GU10  
**Color:** Chrome  
**Material:** Metal  
**Working temperature:**  
**Packaging:** 1/b 100/c 3200/p  
**Certifications:** CE

**TECHNICAL DETAILS**

**Wattage:**  
**Voltage range:** 220-240V  
**Inner diameter:** 55mm  
**Cut out size:** 50mm  
**Swivel:** No  
**IP standard:** IP20

**BOX PICTURE**



## Avide GU10 Frame Square Chrome

**Product code:** ABGU10F-S-CH  
**Brand link:** [avidelighting.com/qr/ABGU10F-S-CH](https://avidelighting.com/qr/ABGU10F-S-CH)  
**ID:** AB-190518  
**Company name:** Bramcke Hungary Kft.  
**Company address:** Kishatár utca 17., 4031 Debrecen



**Date of issue:** 2024-05-21

**Page:** 2/3

### PRODUCT SIZE

**Width:** 74mm  
**Height:** 31mm

### CARDBOARD BOX

**EAN:** 5999097911687  
**Packaging:** 1/b 100/c 3200/p  
**Dimensions:** 92mm x 36mm x 132mm  
**Net weight:** 50.6g  
**Gross weight:** 67.1g

### CARTON

**EAN:** 5999097911694  
**Packaging:** 1/b 100/c 3200/p  
**Dimensions:** 485mm x 220mm x 390mm  
**Net weight:** 5.06kg  
**Gross weight:** 6.71kg

### PALLET EXAMPLE

**Height:**  
**Width:** 120cm (std Euro pallet)  
**Depth:** 80cm (std Euro pallet)  
**Cartons per pallet:** 32carton/pallet  
**Cartons per row:**  
**Net weight:** 161.92kg  
**Gross weight:** 214.72kg

### PRODUCT PICTURE



### PRODUCT OUTLINE

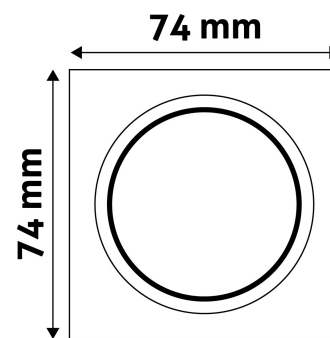

## Avide GU10 Frame Square Chrome

**Product code:** ABGU10F-S-CH  
**Brand link:** [avidelighting.com/qr/ABGU10F-S-CH](https://avidelighting.com/qr/ABGU10F-S-CH)  
**ID:** AB-190518  
**Company name:** Bramcke Hungary Kft.  
**Company address:** Kishatár utca 17., 4031 Debrecen

QR code:



**Date of issue:** 2024-05-21

**Page:** 3/3

## PRODUCT DESCRIPTION